

# Hong Kong Ding Sheng Tian Technology Co., Ltd. (DCT Brand)

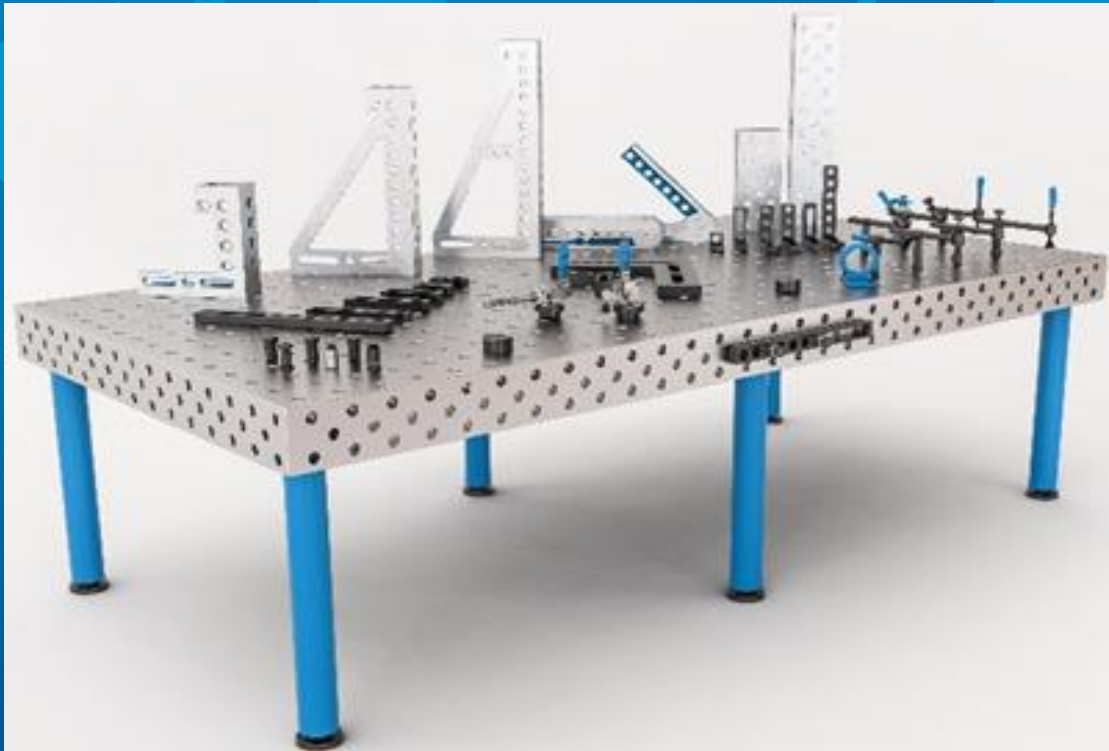

**Email: [info@enjoy-sound.com](mailto:info@enjoy-sound.com)**  
**Website: [www.enjoy-sound.com](http://www.enjoy-sound.com)**

# Pipe Application

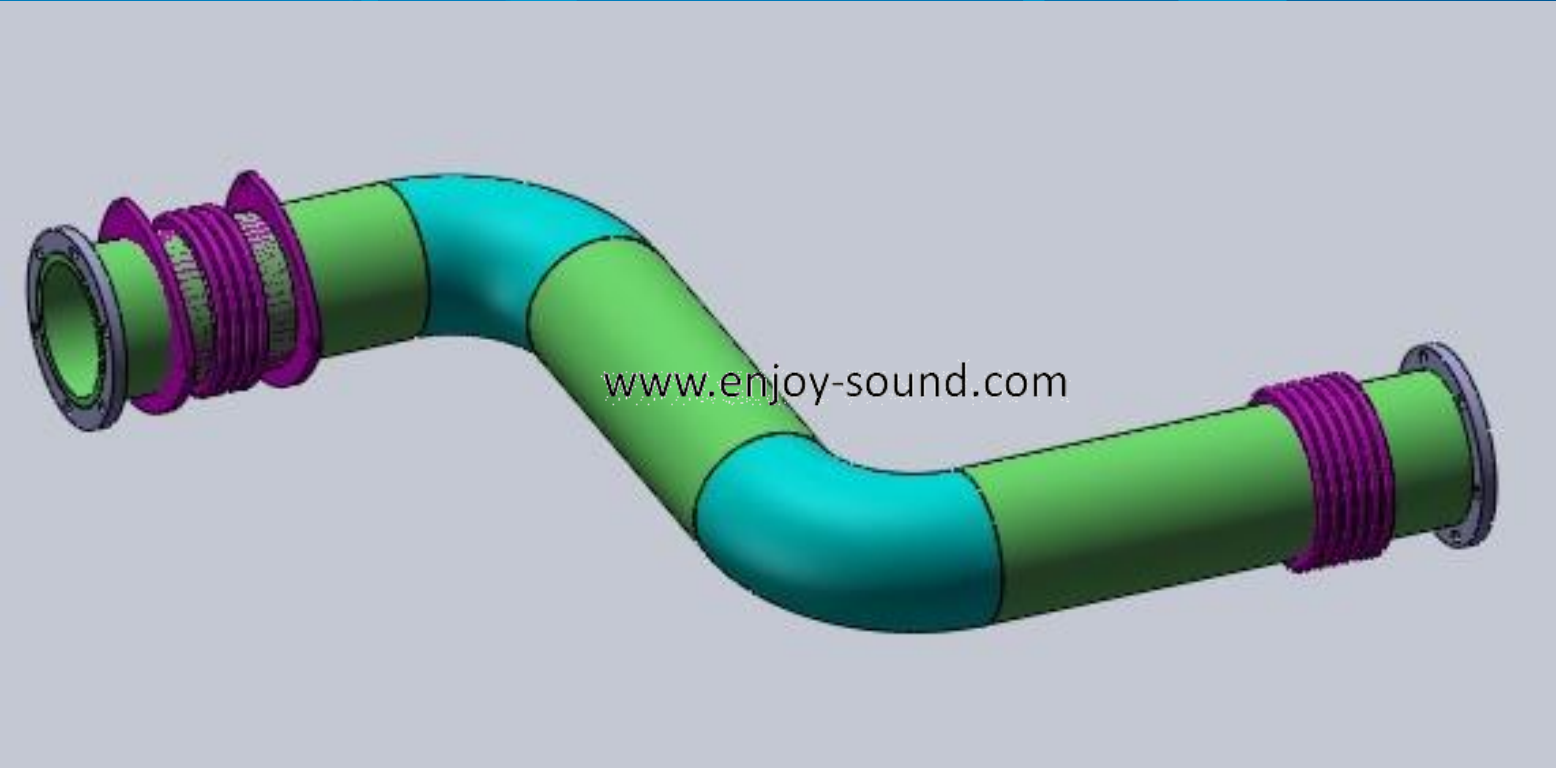

## Application analysis:

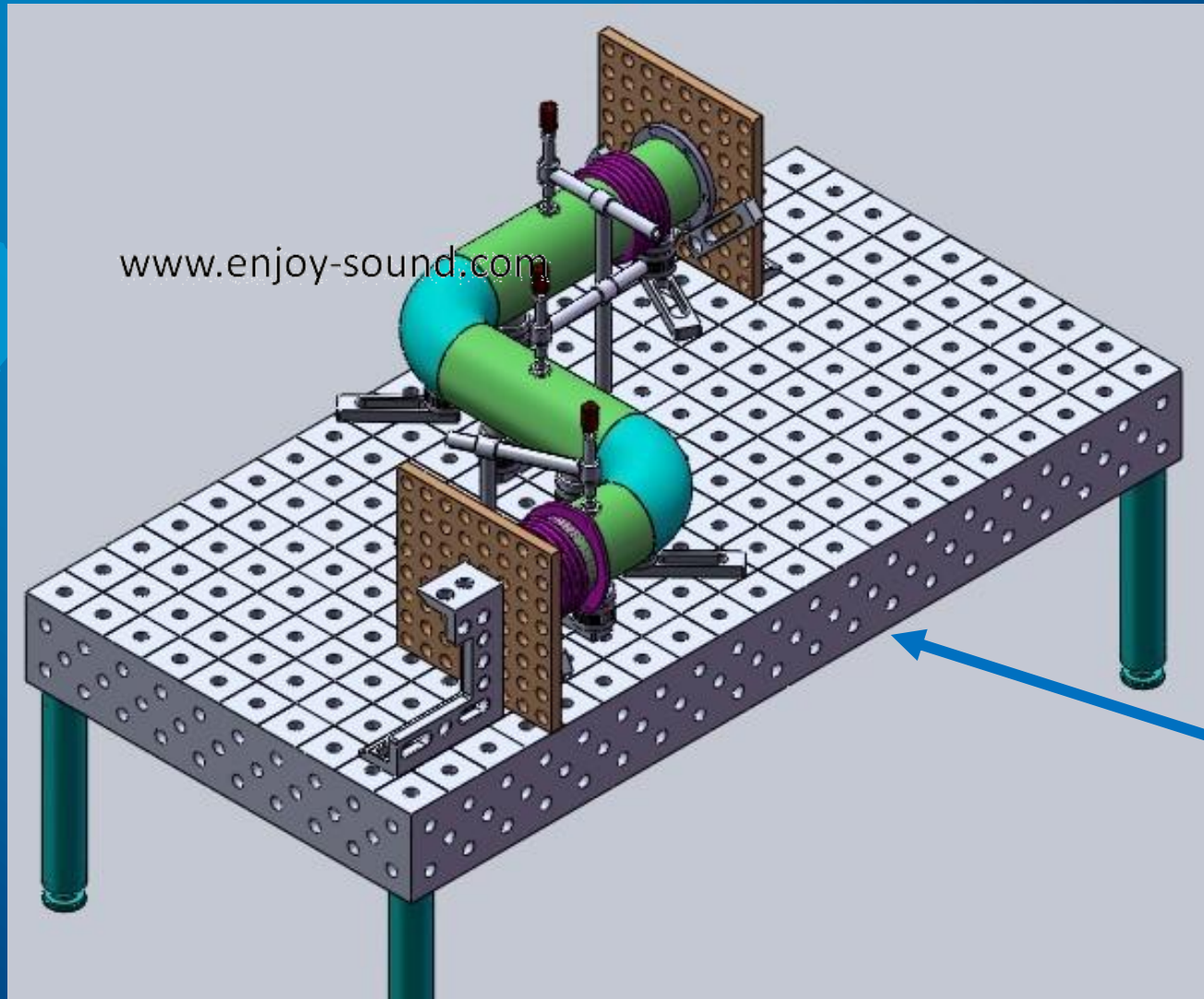

39X78" 3D  
steel welding  
table

The pipe is fixed and clamped on the 3D welding table with locating pins, adapter plate for flanges and clamps

# Application analysis:

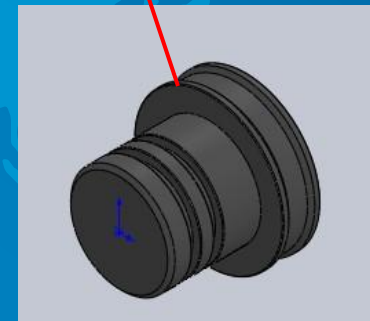
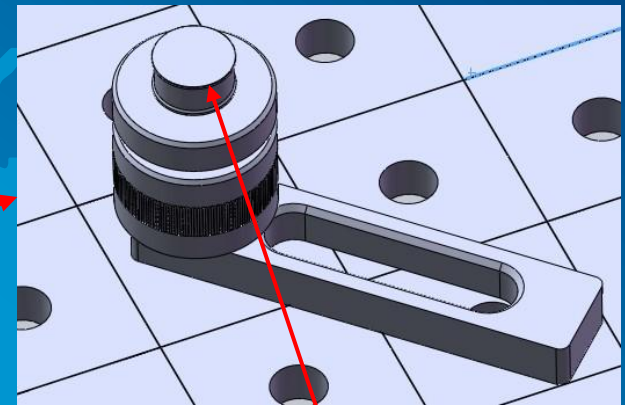
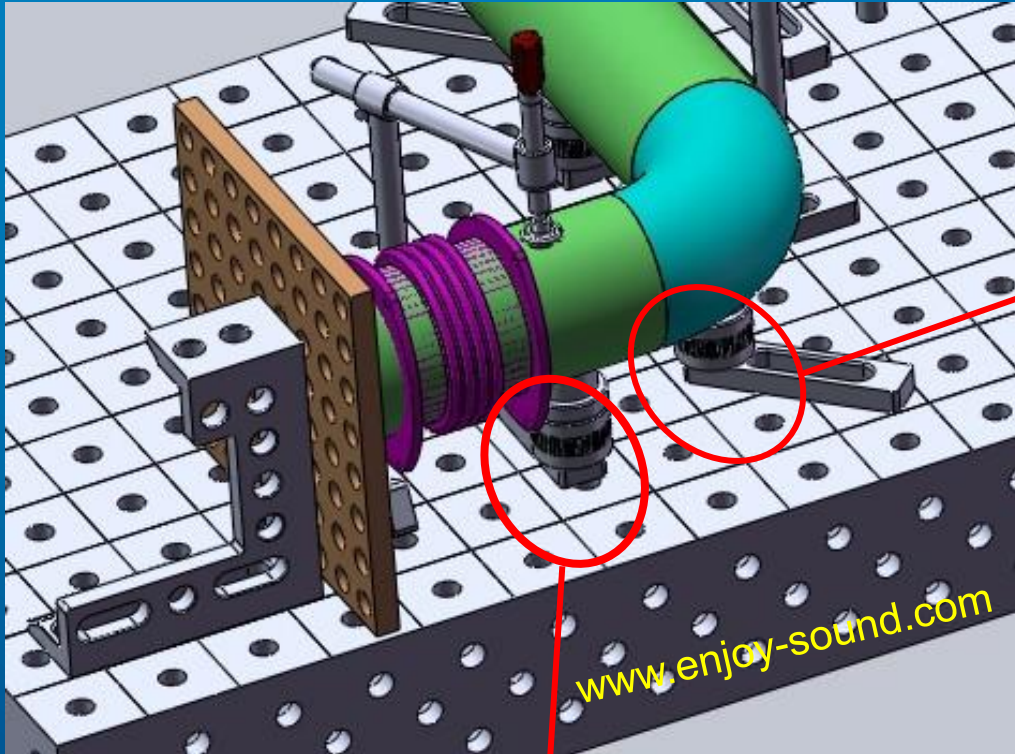

Adjustable spacer

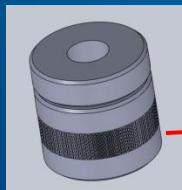

Adjustable space

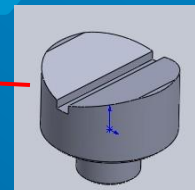
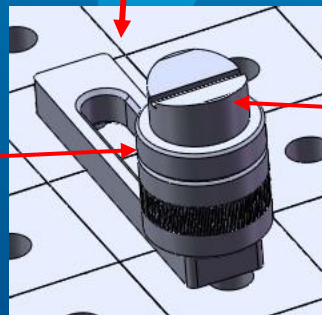

V-block locations

# Application analysis:

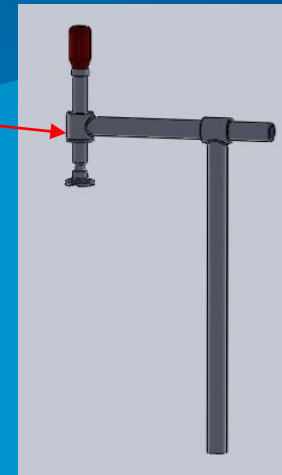
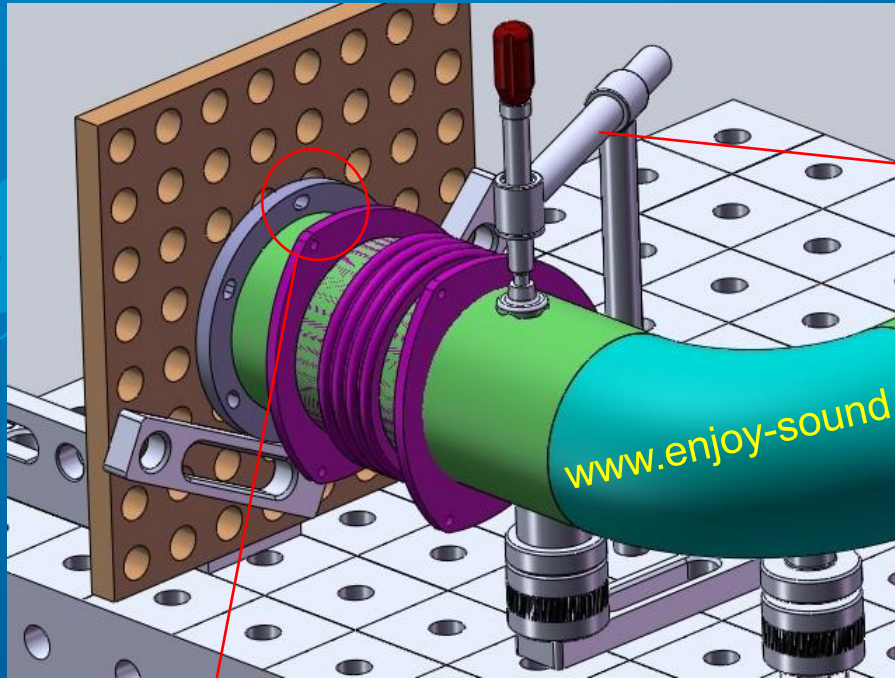

Screw clamp 180° with spindle



Use bolts to connect the pipe and the adapter plate for flanges

# Final Setup

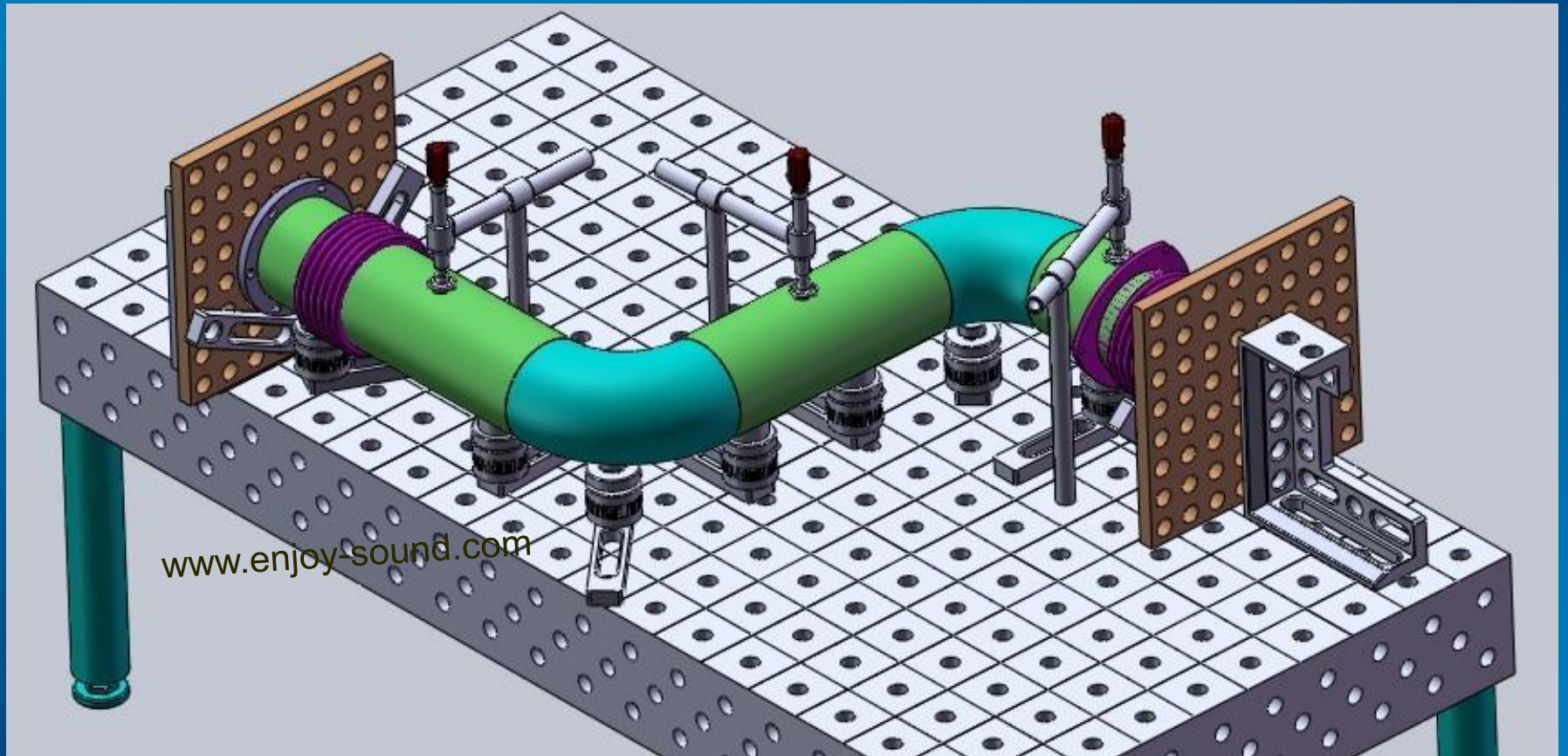

A world map is centered on the page, rendered in a light blue color against a dark blue background. A large, solid red arrow points horizontally from the right side of the map towards the right edge of the frame. The text 'Other 3D Welding Table Applications' is positioned in the lower-left quadrant of the map area.

Other 3D Welding Table Applications

DCT is committed to producing the world's finest welding and fixture tables

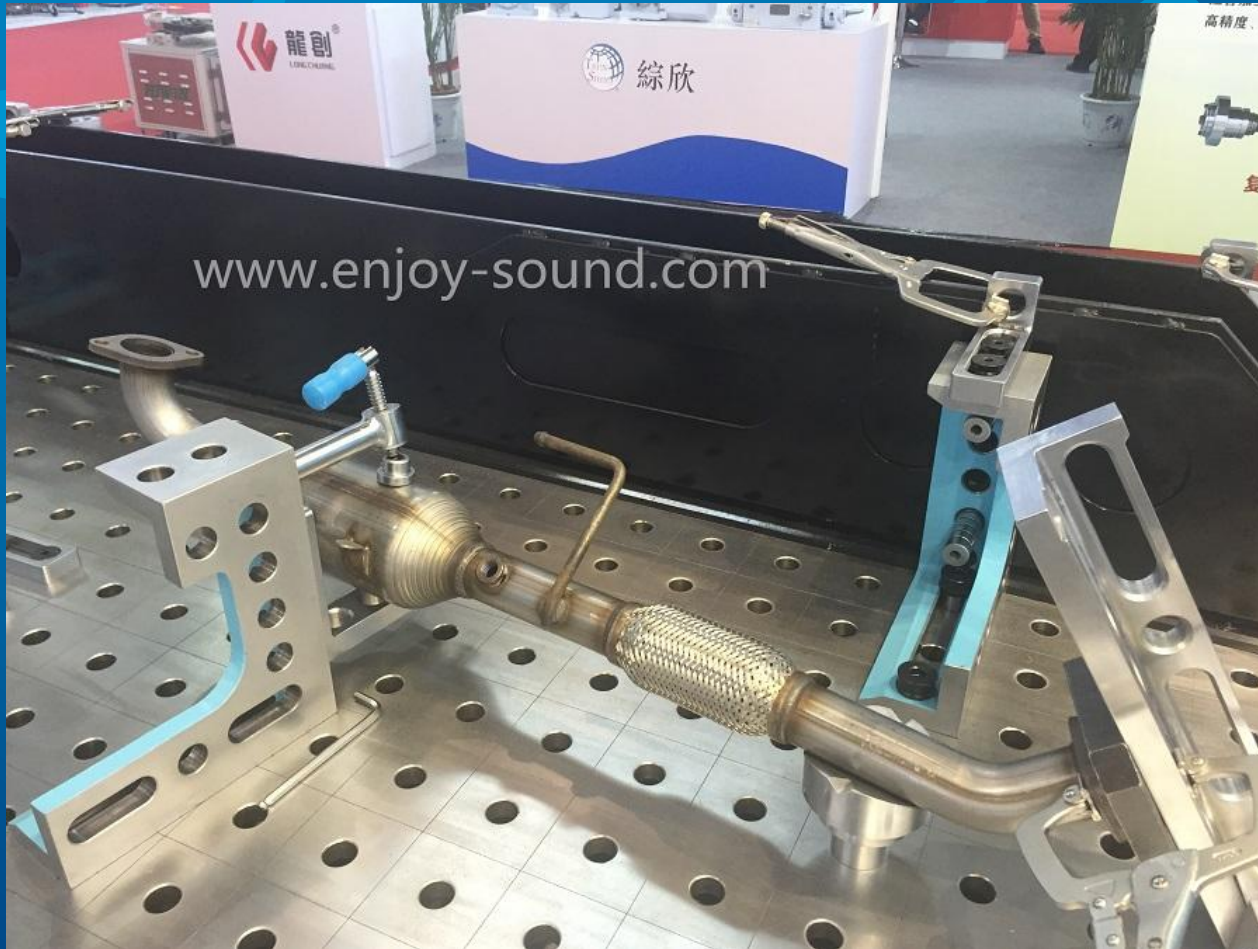



The DCT welding table is one of the most adaptable welding and fixturing tables on the market today.



Our daily mission is to meet and even exceed the high standards of our customers.



Built to last a lifetime and beyond, these tables are constructed with an extremely rigid and flat, five-sided top surface.

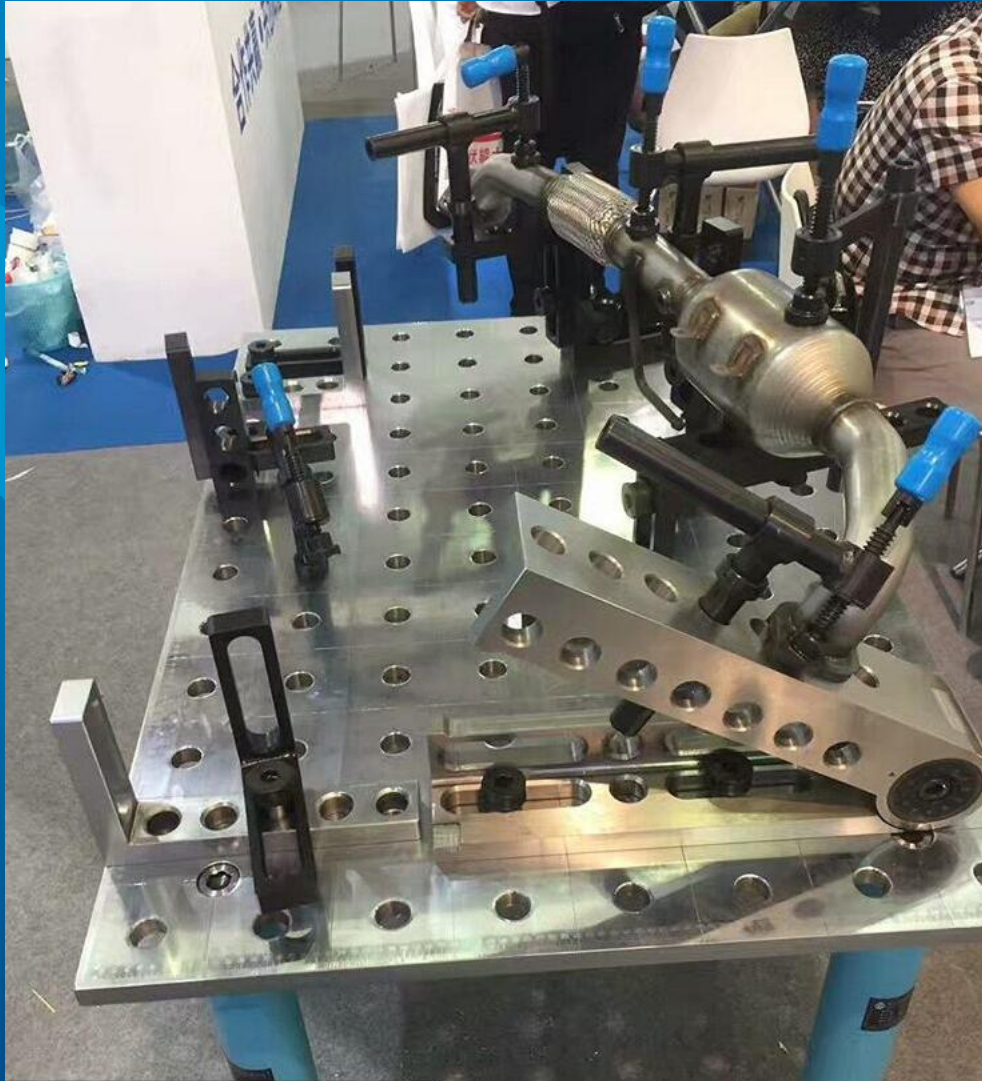

Our welding jig tables are durable and provide you the quality and performance you need to complete any unique job.



[www.enjoy-sound.com](http://www.enjoy-sound.com)

Fabricate accurately with heavy duty DCT Welding Tables.  
Superior quality tables with an extremely flat and rigid five  
face fixturing surface.

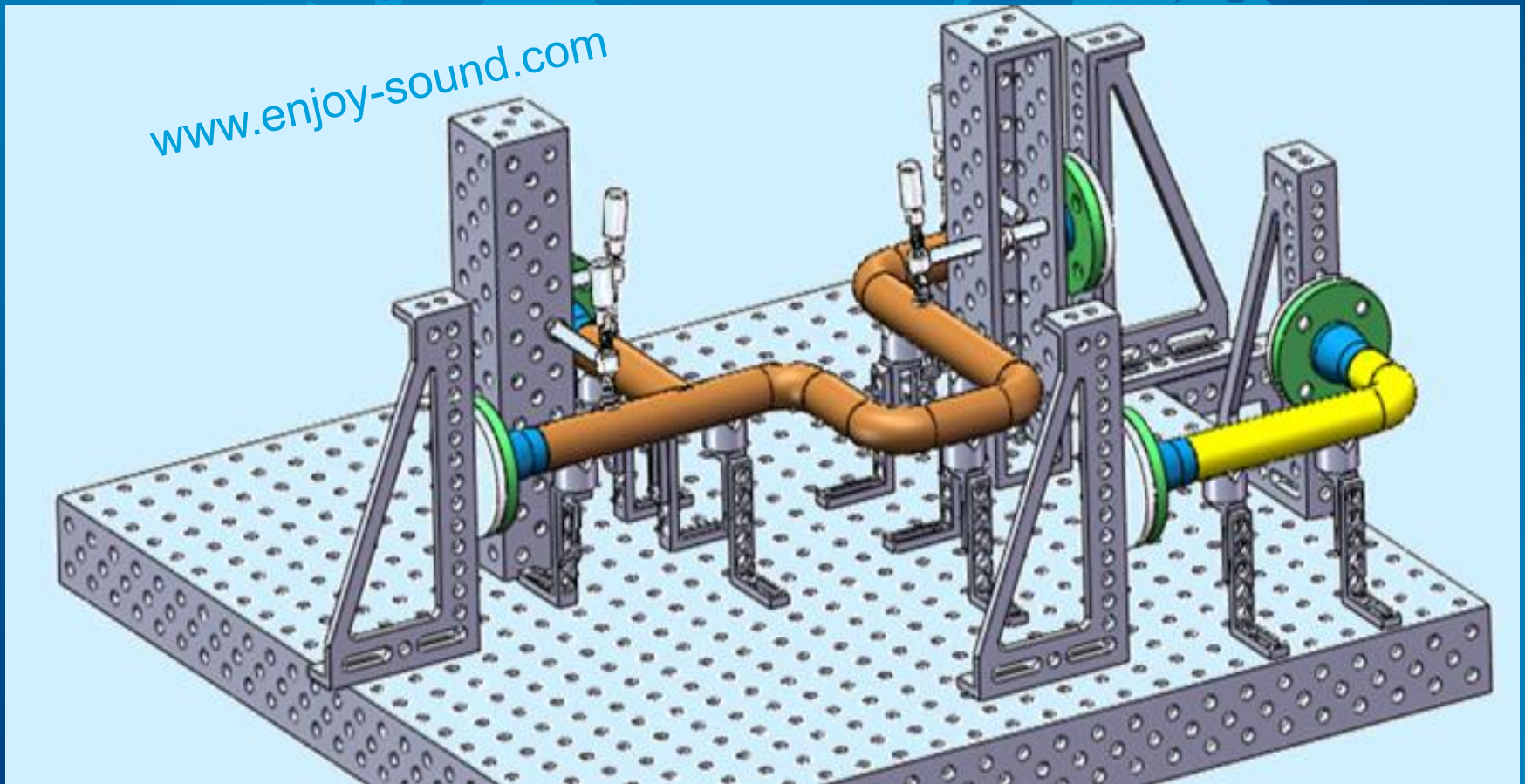

Increased Throughput; Improved Quality; Cost Saving;  
Increased Accuracy; Increased Repeatability; Enhanced  
Safety; Innovative 3D tables and clamping system.

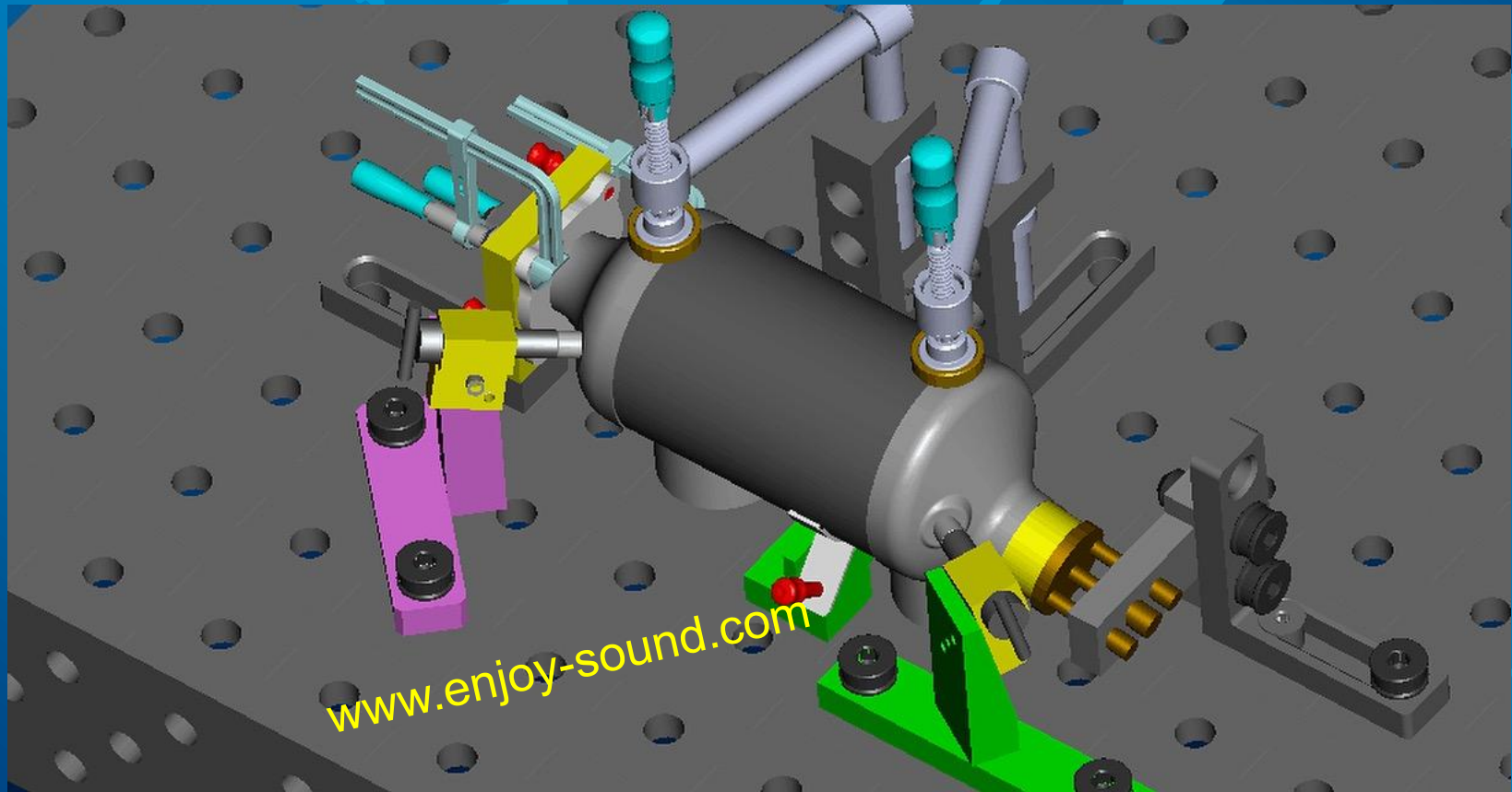

With this system, you can set and fix the specified sizes for any work piece quickly and precisely.

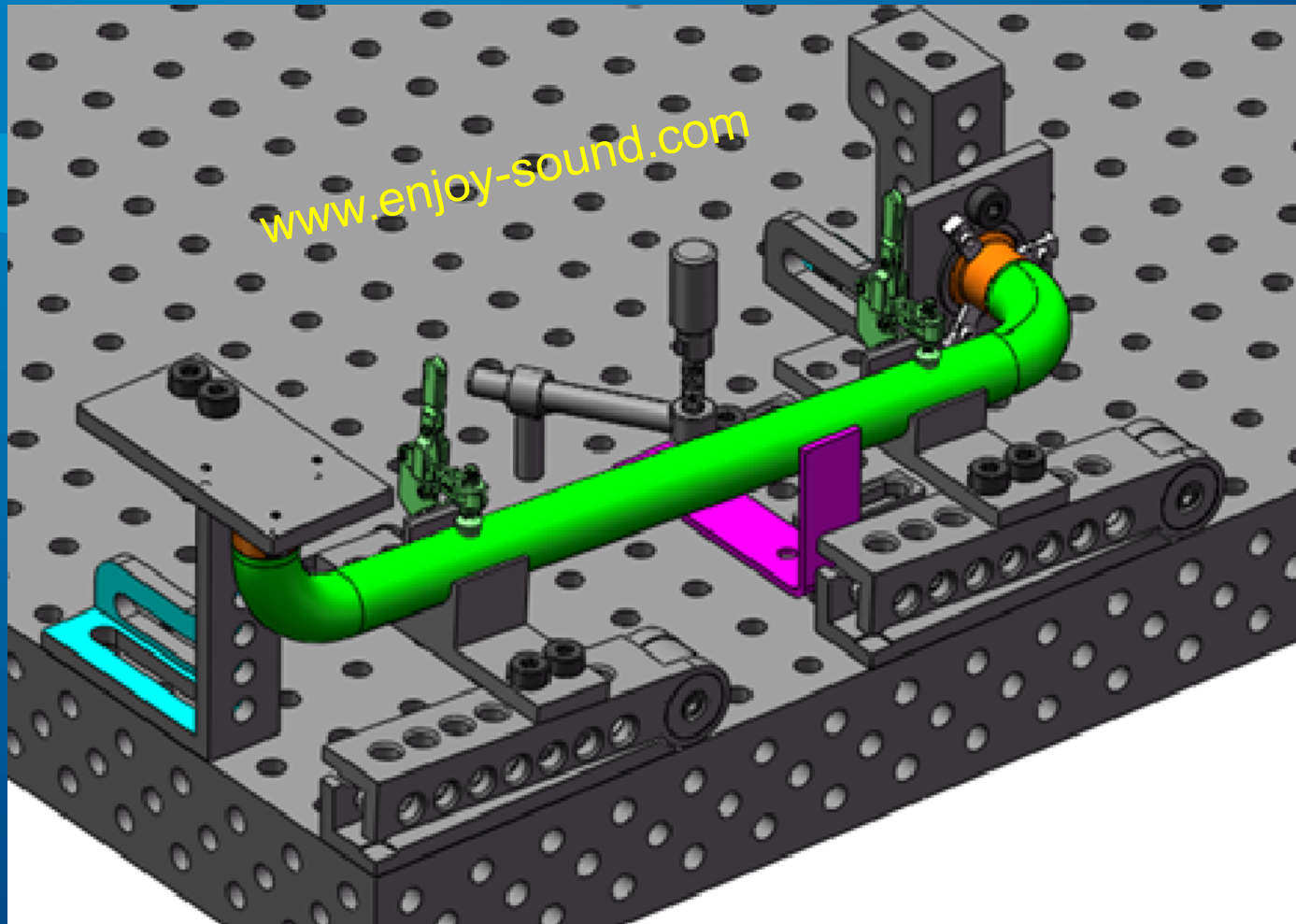

## Contact Info



**Website: [www.enjoy-sound.com](http://www.enjoy-sound.com)**

**E-mail: [susan-chen@enjoy-sound.com](mailto:susan-chen@enjoy-sound.com)  
[Info@enjoy-sound.com](mailto:Info@enjoy-sound.com)**

**Skype: JIG88888**